

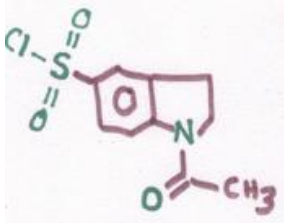
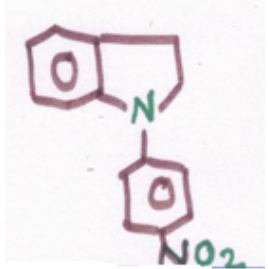
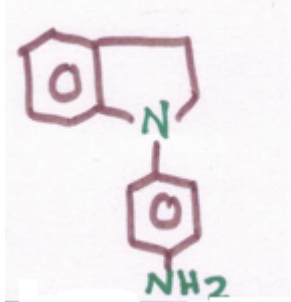
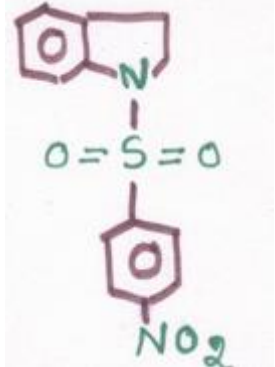
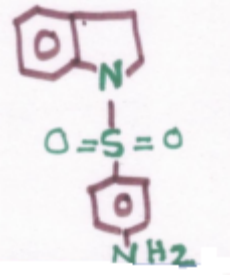
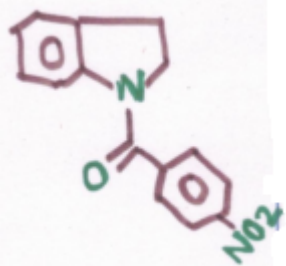
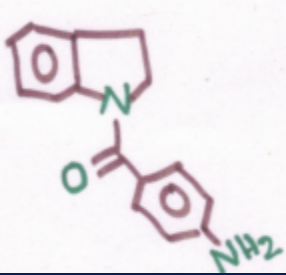
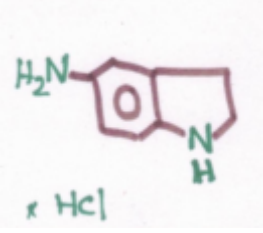
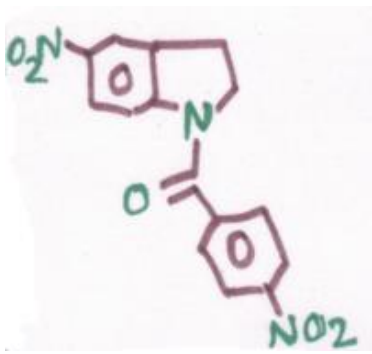
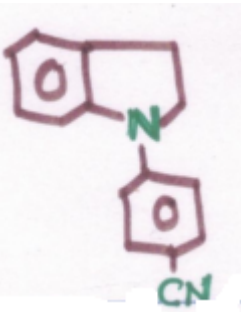
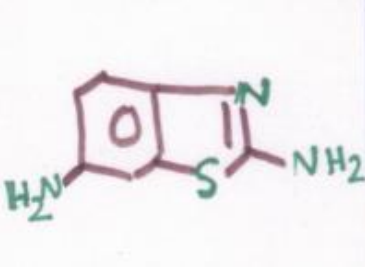
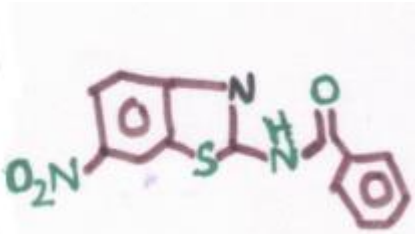
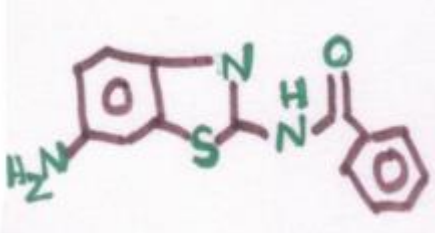
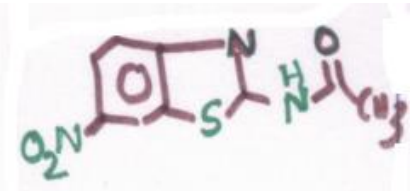
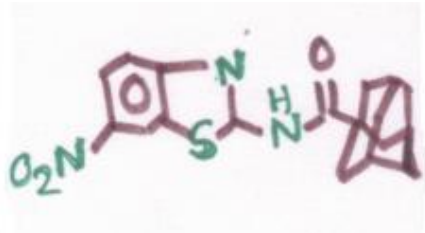
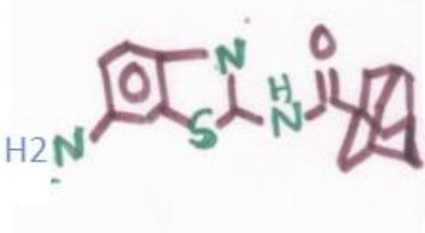
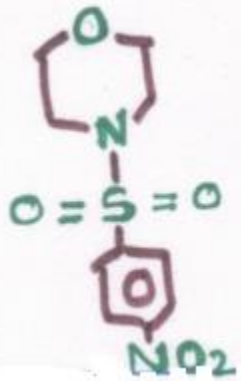
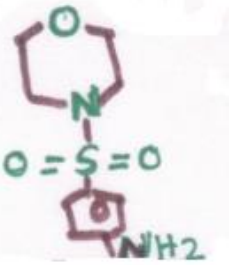

Sl.No	Product Code	Structure	CAS NO& Name	Price
1.	CKIN-1		52206-05-0 1-Acetylindoline-5-sulfonyl chloride	2000.00 / 1g
2.	CKIN-2		1-(4-Nitrophenyl)indoline	15000/ 1g
3.	CKIN-3		4-(Indolin-1-yl)aniline	22000/ 1g
4.	CKIN-4		1-[(4-Nitrophenyl)sulfonyl]indoline	Please Enquire

Sl.No	Product Code	Structure	CAS NO& Name	Price
5.	CKIN-5		314284-67-8 4-(2,3-dihydro-1H-indol-1-ylsulfonyl)aniline	25000/ 1g
6.	CKIN-6		(2,3-dihydro-1H-indol-1-yl)(4-nitrophenyl)methanone	12000/ 1g
7.	CKIN-7		953883-01-7 (4-Aminophenyl)(indolin-1-yl)methanone	15000/ 1g
8.	CKIN-8		1286676-80-9 Indolin-5-amine hydrochloride,	1 g / 22000.00

Sl.No	Product Code	Structure	CAS NO & Name	Price
9.	CKIN-9		(5-nitro-2,3-dihydro-1H-indol-1-yl)(4-nitrophenyl)methanone	Please Enquire
10.	CKIN-10		4-(2,3-dihydro-1H-indol-1-yl)benzonitrile	Please Enquire
BENZOTHAZOLES				
11.	CKBZ-1		5407-51-2 Benzo[d]thiazole-2,6-diamine	1g / 4000.00
12.	CKBZ-2		51126-54-6 N-(6-nitro-1,3-benzothiazol-2-yl)benzamide	1g / 22000.00

Sl.No	Product Code	Structure	CAS NO & Name	Price
13.	CKBZ-3		N-(6-amino-1,3-benzothiazol-2-yl)benzamide	1g / 38000.00
14.	CKBZ-4		80395-50-2 N-(6-nitro-2-benzothiazolyl)acetamide	1g / 22000.00
15.	CKBZ-5		(3r,5r,7r)-N-(6-nitrobenzo[d]thiazol-2-yl)adamantane-1-carboxamide	1g / 15000.00
16.	CKBZ-6		(3r,5r,7r)-N-(6-aminobenzo[d]thiazol-2-yl)adamantane-1-carboxamide	1g / 40000.00

Sl.No	Product Code	Structure	CAS NO & Name	Price
Morpholine				
17.	CKMHP-1		1024-30-2 4-((4-Nitrophenyl)sulfonyl)morpholine	1g / 8000
18.	CKMHP-2		21626-70-0 4-(Morpholinosulfonyl)aniline	1g / 12000
Piperazine				
19.	CKNMP-1		223785-97-5 1-Methyl-4-((4-nitrophenyl)sulfonyl)piperazine	1g/ 12000
20.	CKNMP-2		21623-68-7 4-((4-Methylpiperazin-1-yl)sulfonyl)aniline,	1g/ 15000

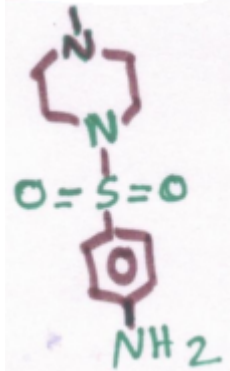
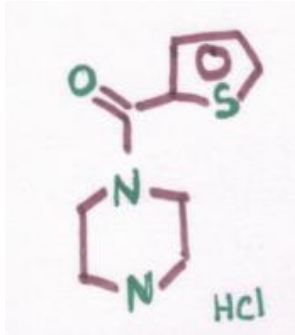
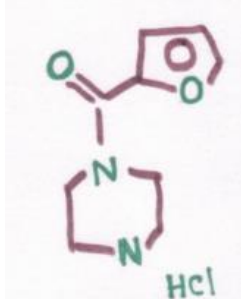
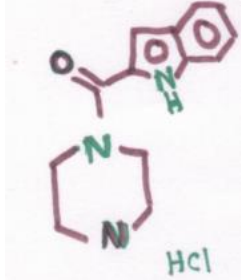
Sl.No	Product Code	Structure	CAS NO	Price
				
21.	CKNMP-3		<p>99580-45-7</p> <p>Piperazin-1-yl thio phen-2-yl) methanone hydrochloride</p>	1g / 7000
22.	CKNMP-4		<p>40172-95-0</p> <p>1-(2-Furoyl)piperazine</p>	1g/ 5000
23.	CKNMP-5		<p>1028800-67-0</p> <p>2-(Piperazine-1-carbonyl)-1H-indole hydrochloride</p>	1g / 7000

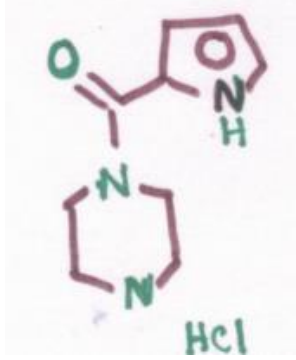
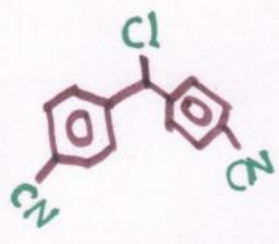
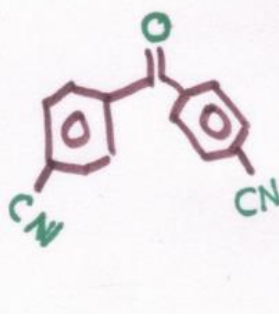
24.	CKNMP-6		1038285-42-5 Piperazin-1-yl(1H-pyrrol-2-yl)methanone	1g / 20000
Sl.No	Product Code	Structure	CAS NO & Name	Price
25.	CKLTZ-1		112809-57-1 4-alpha-(4-Cyanophenyl)-chloromethyl-benzonitrile	1g / 30000
26.	CKLTZ-2		32446-66-5 4,4'-Dicyanobenzophenone	1g / 12000
27.	CKB-1		28952-41-2 1-methyl-4-(4-phenylphenyl)benzene	100 mg/ 25000

				
--	--	---	--	--

CHEMKOVIL OTHER PRODCUTS-2026

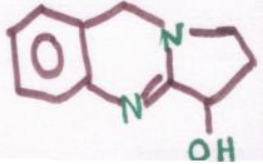
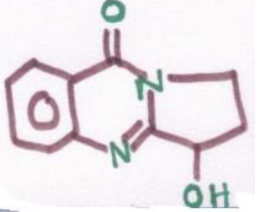
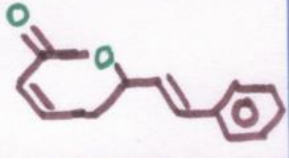
		Natural products			
Sl. No	Compound name	Structure	Specification	Pack size	Price
1.	Vasicine CK-P1 6159-56-4		Light brown solid Purity :96% (by HPLC) NMR : Available HPLC : Available LC-MS: Available	50 mg	48000/+ GST
2.	Vasicinone CK-P2 486-64-6		Light brown solid Purity :96% (by HPLC) NMR : Available HPLC : Available LC-MS: Available	10 mg	22000/+ GST
3.	(R)- Goniothalamine CK-P3 17303-67-2		Off white solid Purity :97% (by HPLC) NMR : Available HPLC : Available LC-MS: Available	10 mg	25000/+ GST
		API impurities			

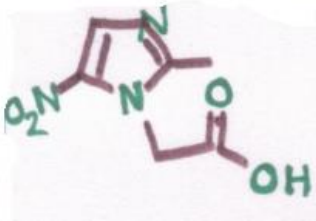
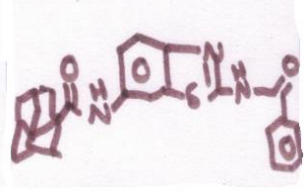
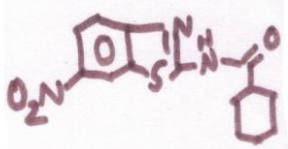
1.	Metronidazole EP Impurity G 1010-93-1		Off white solid Purity :98% (by HPLC) NMR : Available HPLC : Available LC-MS: Available	50 mg	15000/+ GST
Reference standards					
1.	NVP-231 362003-83-6		Pale yellow solid Purity :98% (by HPLC) NMR : Available HPLC : Available LC-MS: Available	25 mg	45000/+ GST
2.	HUP-30 312747-21-0		Pale yellow solid Purity :98% (by HPLC) NMR : Available HPLC : Available LC-MS: Available	50 mg	12000/+ GST